

Robotic Welding Path Identification Using FPGA-Based Image Processing

Abdulkadir SADAY
 Mechatronics Engineering Department
 Faculty of Technology, Selcuk University
 Konya, Turkiye
 Email: asaday@selcuk.edu.tr
 ORCID: 0000-0002-0406-711X

Ilker Ali OZKAN
 Computer Engineering Department
 Faculty of Technology, Selcuk University
 Konya, Turkiye
 Email: ilkerozkan@selcuk.edu.tr
 ORCID: 0000-0002-5715-1040

Abstract— The robotic welding process is widely used in many industry sectors, and its use in production lines is becoming more common day by day. Obtaining a smooth weld seam in robot welding depends on the geometric structure of the welding path and the stability of the control loop. However, the weld path and the weld gap are usually not fixed, and their change negatively affects the automatic control. Programming the complex welding path by the operator may take more time than executing the task for some welding jobs. In addition, the variable weld gap negatively affects the weld quality in the constant control loop. This study proposes a system that provides a real-time definition of the weld path and its geometry on the embedded system to address this issue. The weld path image is captured using a camera, and the weld path is determined by image processing techniques using the embedded Linux operating system running on system-on-chip (SoC) hardware. The images captured through the Hard Processor System (HPS) unit are stored in memory, processed in the FPGA unit, and output by the HPS unit. Unprocessed SoC images and measurement images of weld pieces are presented with their values. When the values obtained from the processed weld path image are compared to manually measured path values, it is seen that the proposed system produces successful results.

Keywords— *FPGA, image processing, robotic welding.*

I. INTRODUCTION

Welding is a process that uses heat energy to join metal materials. It is widely used in most industries for production. With the increase in the use of welding in the industry, robots that can autonomously perform the welding process have started to take their place in the sector quickly. Welding robots not only automate the welding process but also provide the manufacturer speed, time, and safety [1]. Robots can maintain heavy-duty cycles in an unchanging and uninterrupted structure. However, in the automation process, the fact that the application is not under human control causes an uncontrolled process against possible errors.

Automating the welding process with welding robots has several advantages, such as faster production, more consistent cycle times, no downtime in production, and better weld quality. Furthermore, robots play an essential role in lowering corporate safety expenses, minimizing defective manufacturing, and conserving energy. However, in the automation process, not using a control mechanism during the process may cause errors that may occur and not be noticed [2]. There are post-welding quality control systems in existing systems for weld defects, which is one of these faults.

There are different types of automated welding robot systems depending on the industry and purpose of use. These systems are grouped as weld quality monitoring systems, weld test systems, and weld path monitoring systems. Image processing is an essential component of these systems. The

images captured by a camera are pre-processed in the system and turned into output suitable for the intended use [3]. The critical factor in welding systems' image processing applications is obtaining the image clearly and pre-processing it correctly.

Material errors during the welding application, improper placement of materials, or errors in the control system may cause the robot to deviate from the welding path and cause the welding process to be broken. In addition, the gap between the materials to be welded may not always be constant. For this reason, it is necessary to constantly align the welding robots to the welding path and provide feedback to the system [4]. Various sensors and techniques are used in robotic welding systems in order to keep the welding torch in the welding path and to obtain information about the welding path. Intelligent optical sensors, laser sensors, and cameras are the primary sensors used in these systems [5].

In current studies on the determination of the welding path, image processing techniques and operations with various sensors are performed on conventional processors and computers [6]. Image processing techniques require high data processing speed for real-time systems and require multiple task cycles. Unlike other processor types, FPGAs that can meet this need have the ability to perform parallel operations and perform multiple operations simultaneously. This makes FPGAs an advantageous option in image processing applications [7].

In this study, it is proposed to use an FPGA-based system for welding robots in order to monitor the welding path in real-time and to obtain the welding gap using image processing techniques. In the study, a development board called SoC (System-on-chip), containing FPGA and HPS units hardware together, was used. The materials to be welded were visualized with the help of the camera hardware connected to the HPS unit, and the images obtained were transferred to the FPGA unit over the HPS-FPGA bridge and processed. The line laser projected onto the weld gap during image acquisition from the materials was used to assist in the correct extraction of the weld path geometry. The welding path data obtained from the images were output to the HPS unit and saved as a parameter for use in the control system.

II. SYSTEM DESIGN

The system prepared for the extraction of the weld path consists of the Altera DE1-SoC development board, camera, monitor, and line laser module. The SoC hardware has an embedded HPS and FPGA unit. The monitor in the system is used for monitoring and parameter display during the operation. The block diagram of the proposed system is given in Figure 1.

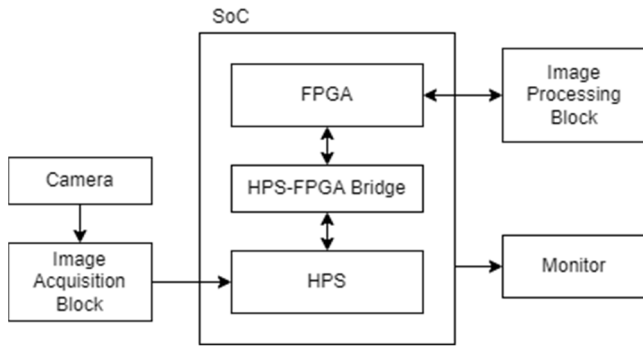

Fig. 1. System block diagram

In the system, the camera and line laser module are mounted on the front of the welding torch. Thus, during the robot movement, the welding path can be determined in advance, and feedback to the control system can be provided. The camera and line laser connection format is shown in Figure 2.

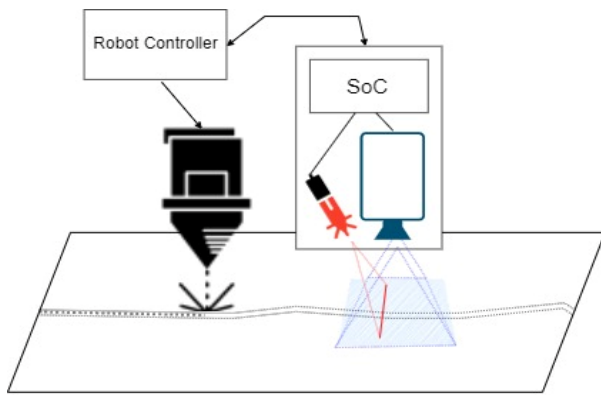

Fig. 2. Camera and line laser assembly demonstration

The SoC hardware is responsible for capturing the image from the camera, processing the captured image, and transferring it to the screen as output. The system's software is divided into two different units: image acquisition block and image processing block. The image acquisition block is run on HPS, and the image processing block is run on FPGA. The connection between HPS and FPGA is established via the HPS-FPGA bridge. The resulting data from the processed image is shown on the HPS output screen.

III. EXPERIMENTAL STUDY

In this research, a study was carried out to map the welding path by using image processing techniques for welding robots.

The steps of the system are grouped as capturing the image from the camera, pre-processing the image, transferring the data between the units, processing the image, and transferring it to the screen as output. The block diagram of the system operation is given in Figure 3.

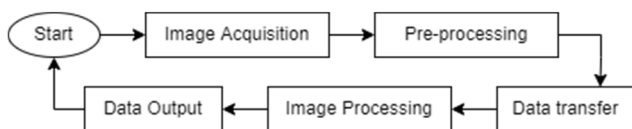

Fig. 3. System operation diagram

A. Preparation of the System

SoC hardware is generally defined as complex circuits that include a programmable processor, on-chip memory, data transfer bridges, and reconfigurable logic gates [8]. They can be configured in different ways, depending on their intended use.

For the SoC hardware used in this study, the HPS unit is programmed to capture images from the camera and undergo pre-processing. The FPGA unit is configured to extract and return the desired information from the pre-processed data. The output data is displayed on the screen by connecting a monitor to the system via the VGA output on the hardware.

HPS unit consists of an ARM Cortex processor and can run embedded Linux versions [9]. For this section, first of all, the Linux operating system was installed on the HPS unit. For the control of the system, the necessary network settings are defined by making a network connection to the hardware. In order for the study to support different camera types and communication protocols, the camera setup was done on the HPS unit.

The FPGA unit is generally programmed through the software provided by the hardware manufacturer. In this study, SoC hardware is defined as customized hardware in MATLAB software due to its ease of implementation, and programming is provided via MATLAB. HDL Coder and HDL Workflow Advisor plug-ins are used to program the FPGA hardware over MATLAB. The line laser module can operate with a 3-5V supply voltage and is connected to the FPGA unit.

B. Camera Image Acquisition and Pre-Processing

The method of obtaining the image to be processed varies depending on the application structure and application area. Due to its nature, the FPGA cannot directly read image files. In order for an image to be processed on an FPGA, it must first be converted to binary type [10]. However, camera types that require drivers cannot be run directly on FPGA hardware. For this reason, for this research, a USB camera was introduced to the embedded Linux operating system, and images were captured and pre-processed. Capturing the image from the HPS unit is an important factor in that the ARM architecture supports different camera types, and thus the system can be easily adapted to different structures.

There are many different libraries for image processing applications with the Linux operating system. The OpenCV library is widely used due to its support for different platforms and multiprocessor support [11]. In this study, the OpenCV library was used to capture the welding path image, and a Python application was used to access the camera. The image captured from the camera of the welding materials is given in Figure 4.

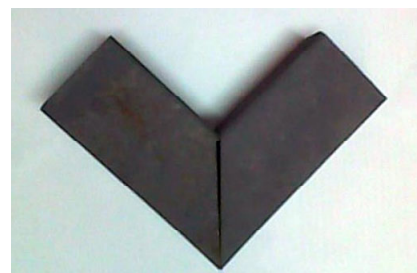

Fig. 4. Welding material camera view

In SoC hardware, data must be transferred to and read from memory in order to transfer between units. Raw images need to be pre-processed before the transfer, as they will take up a lot of memory when transferring between units. At this stage, the image captured from the camera is reduced to a single channel image and converted to binary type, respectively. Channel reduction reduces the image size to be transmitted three times. Binary transform provides the logical expression of an 8-bit image file. The image, which is pre-processed in the HPS unit with OpenCV, is transferred to the memory in the form of a text file. The final binary image that is pre-processed and transferred to the FPGA unit is given in Figure 5.

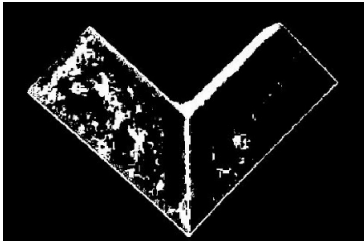

Fig. 5. Pre-processed binary welding material image

C. Data Transfer Between Units

Communication between the HPS unit and the FPGA unit is via memory or customized bridges. The HPS-FPGA bridge is used to transfer data from the HPS unit to the FPGA unit, FPGA-HPS bridge is used for data transfer from the FPGA unit to the HPS unit. In Altera SoC hardware, this bridge is called AXI (Advanced eXtensible Interface). For the design of the bridge system, the manufacturer's Qsys application is used [12].

In FPGA and ARM units, the access of the programs to the components is provided through addresses. Correct addressing is extremely important for communication. At this stage, system parameters, pin assignments, and timing constants are made on SDRAM. The ARM processor opens the system memory device driver using an explicit system call through a C program and uses it to map the HPS physical address to the virtual address. The C program prepared for data transfer is compiled and run on the system with the ARM SoC EDS program installed in the HPS unit.

After pre-processing, the image converted to binary is written to disk in the form of a text file. The C program prepared for data transfer reads the text file from the disk and transfers the data to the memory via the address defined in SDRAM. In the FPGA unit, the data transferred to the memory is read from the same virtual address, mapped to the physical address, and made ready for processing. The point to be considered here is that the transferred data is configured in such a way that it does not exceed the FPGA memory. Otherwise, the original image will be destroyed because the read image file will be missing.

D. Image Processing

The use of FPGA in image processing applications provides high performance compared to other processor types. This is a result of the FPGA's ability to perform differing or the same types of operations in parallel, access memory blocks in parallel, and have a high operation rate. Many image processing applications have a parallel structure, and the parallel structure of FPGA allows these applications to be run simultaneously [7].

Image processing is used to perform functions such as transmission, identification, storage, and restoration of an image. In addition, they are defined as functions that enable machines to interpret images, called machine vision. The digital image is expressed as a function of the coordinate and brightness information corresponding to each point in the X-Y coordinate system. Image processing applications also provide interpretation of the image with the help of various mathematical operations called filters by using digital coordinates and brightness information [13].

In the study, the image data obtained as binary and passed through certain pre-processes for the FPGA was read from memory and assigned to a variable in the VHDL program. The part of the interest in the image is the range to be welded. Processing a whole image will consume more memory as well as time. For this reason, positioning the camera to see only the area of interest is important for the system to work more stable and to obtain the desired data faster. In the system, the camera is positioned to see only the welding path, and the image is captured. The pre-processed image of the welding path is given in Figure 6.

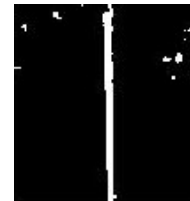

Fig. 6. Pre-processed weld path image

The gap between the materials to be welded is not always regular and smooth. The realistic extraction of the welding path and the adjustment of the welding parameters according to the geometry of the path significantly affect the quality factor in robot welding systems. Welding with fixed system parameters and variable geometry will cause production errors. For this reason, the welding path should be obtained from the image as detailed as possible.

In the weld path image in Figure 6, it is seen that the gap between the materials is not smooth, and there are noises originating from the material in the image captured. In order to extract the welding path parameters properly, the noise must be removed from the image first. Noise removal on the image is provided by filters. The median filter is a non-linear digital filter that selects the midpoint by ordering the values of neighboring points to remove noise. It is often preferred in image processing applications because it ensures that details are not lost [14]. In the study, a Median filter was used to remove light and material surface noises from the welding path. The image obtained after filtering is given in Figure 7.



Fig. 7. Weld path image cleared of noise

After the noise removal process, the image is ready for the extraction of the geometry of the weld path. Extraction of geometry from the image can be achieved with edge detection filters.

Many different algorithms have been developed for edge detection. The Canny filter is widely used because it shows high edge detection performance even in the presence of noise [15]. For a precise measurement in determining the welding path, the Canny filter is applied to the noise-removed image.

After the edge determination process, mathematical operations were used to measure the weld path. Inter-edge measurement was achieved by tracking and marking changes in the image data. For this process, the binary image file is scanned, and the points where the data changes are marked. The minimum and maximum values of the data for each row are determined, and the difference is taken. The actual width of the measurement is determined by proportioning the image size and the area actually seen by the camera. The measurement on the image was made with the periods determined in the FPGA. The measurement period can be adjusted at the desired value in the program depending on the application and FPGA capacity. The image of edge detection and width measurement is given in Figure 8.



Fig. 8. Edge detection and gap width measurement output

It is not possible to operate directly on decimal numbers in FPGA. For this reason, operations are provided with the help of a decimal number library called fixed-point. Since the welding path width can be decimal, calculation and data storage operations are done in fixed-point type. The resulting data was stored through the FPGA-HPS bridge and saved as a file in the HPS unit.

IV. RESULTS AND FUTURE STUDY

Determining and monitoring the welding path in the robot welding system will help prevent errors that may occur in the welding process. In this study, a machine vision system for welding robots is designed and implemented on SoC hardware. The width of the welding path was obtained in millimeters on the raw image captured from the camera and printed on the system screen. In addition, the welding path width and geometry can be transferred to the welding robot controller via the hardware so that the welding parameters can be adjusted adaptively.

In some welding applications, the depth of the weld path is important, along with the material spacing. The use of the line laser module during the extraction of the weld geometry will enable alignment and depth measurement operations. In the diagram shown in Figure 1, the angle of the laser module with the surface and its distance from the material surface will help calculate the depth in the weld path. For the calculation process, the refraction of the laser trace on the surface is used. In future work, the depth of the welding path will be calculated with the laser module. By using the cross-laser module, adaptive parameter extraction will be done to align the robot on the welding path. The sample pre-processing image prepared with the line laser is shown in Figure 9.

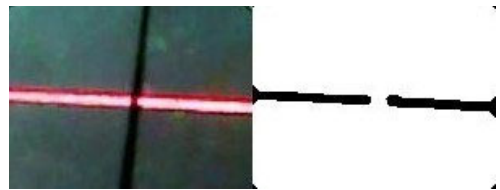

Fig. 9. Future work, path depth calculation with line laser module

Experimental work shows that using SoC hardware, the welding path for robots can be successfully determined with the image captured from the camera. The hybrid structure, in which HPS and FPGA are used together, enables different system and camera types to be supported. This will help reduce the machine vision system cost for welding robots.

ACKNOWLEDGMENT

This study was based on an ongoing doctoral thesis by the first author.

REFERENCES

- [1] R. Singh, Applied welding engineering: processes, codes, and standards. Butterworth-Heinemann, 2020.
- [2] K. Lee, I. Hwang, Y.-M. Kim, H. Lee, M. Kang, and J. Yu, "Real-time weld quality prediction using a laser vision sensor in a lap fillet joint during gas metal arc welding," *Sensors*, vol. 20, no. 6, p. 1625, 2020.
- [3] Z. H. Yuan, W. T. Liu, and X. W. Han, "The weld image acquisition and pre-processing based on FPGA," in *Applied Mechanics and Materials*, 2013, vol. 401: Trans Tech Publ, pp. 1507-1513.
- [4] J. E. Agapakis, J. M. Katz, J. M. Friedman, and G. N. Epstein, "Vision-aided robotic welding: an approach and a flexible implementation," *The International Journal of Robotics Research*, vol. 9, no. 5, pp. 17-34, 1990.
- [5] K. Hang and G. Pritschow, "Reducing distortions caused by the welding arc in a laser stripe sensor system for automated seam tracking," in *ISIE'99. Proceedings of the IEEE International Symposium on Industrial Electronics (Cat. No. 99TH8465)*, 1999, vol. 2: IEEE, pp. 919-924.
- [6] T. Sääntti, O. Lahdenoja, A. Paasio, M. Laiho, and J. Poikonen, "Line Detection on FPGA with parallel sensor-level segmentation," in *2014 14th International Workshop on Cellular Nanoscale Networks and their Applications (CNNA)*, 2014: IEEE, pp. 1-2.
- [7] T. Saegusa, T. Maruyama, and Y. Yamaguchi, "How fast is an FPGA in image processing?," in *2008 International Conference on Field Programmable Logic and Applications*, 2008: IEEE, pp. 77-82.
- [8] C. Cooke, H. McNelly, and T. Martin, "Surviving the SOC Revolution: A Guide to Platform-Based Design," ed: Kluwer, 1999.
- [9] Terasic, *DE1-SoC User Manual*. Altera Corporation, 2019.
- [10] D. G. Bailey, *Design for embedded image processing on FPGAs*. John Wiley & Sons, 2011.
- [11] G. Bradski and A. Kaehler, *Learning OpenCV: Computer vision with the OpenCV library*. "O'Reilly Media, Inc.", 2008.
- [12] Terasic, *Cyclone V Device Handbook: Hard Processor System Technical Reference Manual*. Altera Corporation, 2012.
- [13] M. M. Petrou and C. Petrou, *Image processing: the fundamentals*. John Wiley & Sons, 2010.
- [14] R. Chandel and G. Gupta, "Image filtering algorithms and techniques: A review," *International Journal of Advanced Research in Computer Science and Software Engineering*, vol. 3, no. 10, 2013.
- [15] M. C. NM and K. R. Reddy, "Implementation of canny edge detection algorithm on FPGA and displaying an image through VGA interface," *International Journal of Engineering and Advanced Technology (IJEAT)*, vol. 2, no. 6, pp. 243-247, 2013.